

Q. No. 1 – 25 Carry One Mark Each

1. A streamline and an equipotential line in a flow field
 (A) Are parallel to each other (B) Are perpendicular to each other
 (C) Intersect at an acute angle (D) Are identical

Answer: - (B)

Explanation:- $\left(\frac{dy}{dx}\right)_\phi \times \left(\frac{dy}{dx}\right)_\psi = -1$

Slope of equipotential Line \times slope of stream function = -1

They are orthogonal to each line other.

2. If a mass of moist air in an airtight vessel is heated to a higher temperature, then
 (A) Specific humidity of the air increases
 (B) Specific humidity of the air decreases
 (C) Relative humidity of the air increases
 (D) Relative humidity of the air decreases

Answer: - (D)

Explanation:- R.H. Decreases

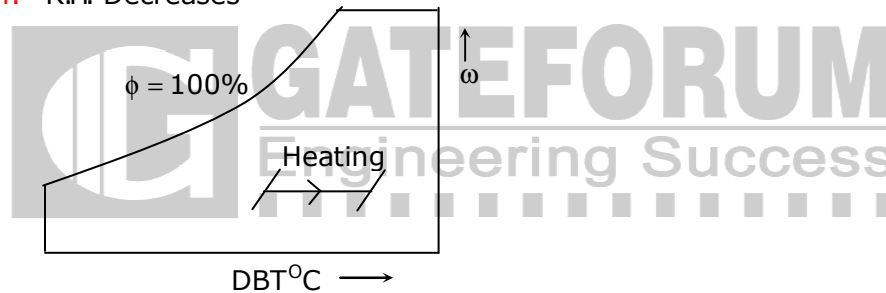

3. In a condenser of a power plant, the steam condenses at a temperature of 60°C . The cooling water enters at 30°C and leaves at 45°C . The logarithmic mean temperature difference (LMTD) of the condenser is
 (A) 16.2°C (B) 21.6°C (C) 30°C (D) 37.5°C

Answer: - (B)

Explanation: - Flow configuration in condenser as shown below.

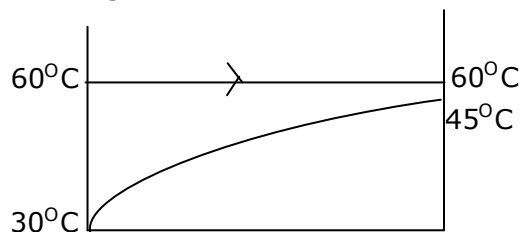

$$\Delta T_1 = 30^\circ\text{C}, \Delta T_2 = 15^\circ\text{C}, \text{LMTD} = \frac{\Delta T_1 - \Delta T_2}{\ln\left(\frac{\Delta T_1}{\Delta T_2}\right)} = \frac{30 - 15}{\ln\left(\frac{30}{15}\right)} = 21.6^\circ\text{C}$$

4. A simply supported beam PQ is loaded by a moment of 1kN-m at the mid-span of the beam as shown in the figure. The reaction forces R_P and R_Q at supports P and Q respectively are

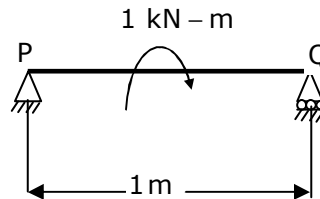

- (A) 1kN downward, 1kN upward (B) 0.5kN upward, 0.5kN downward
(C) 0.5kN downward, 0.5kN upward (D) 1kN upward, 1kN upward

Answer: - (A)

Explanation: - Take moments about 'Q'

$$R_Q \times 1 - 1 = 0 \Rightarrow R_Q = 1\text{kN} \uparrow$$

$$\text{But } R_P + R_Q = 0 \Rightarrow R_P = -R_Q = -1\text{kN or } R_P = 1\text{kN} \downarrow$$

5. A double - parallelogram mechanism is shown in the figure. Note that PQ is a single link. The mobility of the mechanism is

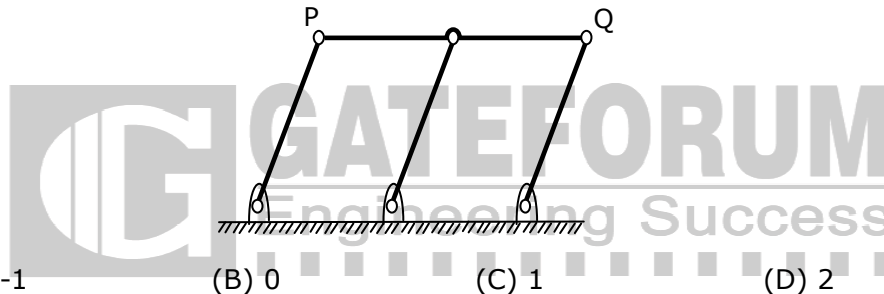

- (A) -1 (B) 0 (C) 1 (D) 2

Answer: - (C)

6. The maximum possible draft in cold rolling of sheet increases with the
(A) Increase in coefficient of friction (B) Decrease in coefficient of friction
(C) Decrease in roll radius (D) Increase in roll velocity

Answer: - (A)

7. The operation in which oil is permeated into the pores of a powder metallurgy product is known as
(A) Mixing (B) Sintering (C) Impregnation (D) Infiltration

Answer: - (C)

8. A hole is dimension $\phi 9^{+0.015}$ mm. The corresponding shaft is of dimension $\phi 9^{+0.010}$ mm. The resulting assembly has

- (A) Loose running fit (B) Close running fit
(C) Transition fit (D) Interference fit

Answer: - (C)

9. Heat and work are
 (A) Intensive properties (B) Extensive properties
 (C) Point functions (D) Path functions

Answer: - (D)

Explanation: - Heat and work are path functions.

Since δQ and δW are dependent on path followed between two given end states of a thermodynamic process undergone by system.

10. A column has a rectangular cross-section of 10mm x 20mm and a length of 1m. The slenderness ratio of the column is close to
 (A) 200 (B) 346 (C) 477 (D) 1000

Answer: - (B)

Explanation:-

$$\text{Slenderness ratio} = \frac{\text{length of column}}{\text{least radius of gyration}} = \frac{L}{K}$$

$$\text{But } K = \sqrt{\frac{I_{\min}}{A}}$$

Where I_{\min} is minimum area moment of inertia i.e. I_{xx} or I_{yy} , whichever is less.

$$\text{For the given section } I_{\min} = \frac{20 \times 10^3}{12} = 1667 \text{mm}^3$$

$$\therefore K = \sqrt{\frac{1667}{20 \times 10}} = 2.89 \text{ and ratio} = \frac{1000}{2.89} = 346$$

11. A series expansion for the function $\sin \theta$ is

- (A) $1 - \frac{\theta^2}{2!} + \frac{\theta^4}{4!} - \dots$ (B) $\theta - \frac{\theta^3}{3!} + \frac{\theta^5}{5!} - \dots$
 (C) $1 + \theta + \frac{\theta^2}{2!} + \frac{\theta^3}{3!} + \dots$ (D) $\theta + \frac{\theta^3}{3!} + \frac{\theta^5}{5!} + \dots$

Answer:- (B)

Explanation:- $\sin x = x - \frac{x^3}{3!} + \frac{x^5}{5!} - \dots$

12. Green sand mould indicates that
 (A) Polymeric mould has been cured (B) Mould has been totally dried
 (C) Mould is green in colour (D) Mould contains moisture

Answer: - (D)

13. What is $\lim_{\theta \rightarrow 0} \frac{\sin \theta}{\theta}$ equal to?

- (A) θ (B) $\sin \theta$ (C) 0 (D) 1

Answer: - (D)

Explanation: - Applying L' Hospitals rule, we have $\lim_{\theta \rightarrow 0} \frac{\cos \theta}{1} = \cos 0 = 1$

14. Eigen values of a real symmetric matrix are always
 (A) Positive (B) Negative (C) Real (D) Complex

Answer: - (C)

Explanation: - Eigen values of a real symmetric matrix are always real

15. A pipe of 25mm outer diameter carries steam. The heat transfer coefficient between the cylinder and surroundings is $5\text{W/m}^2\text{K}$. It is proposed to reduce the heat loss from the pipe by adding insulation having a thermal conductivity of 0.05W/mK . Which one of the following statements is TRUE?
 (A) The outer radius of the pipe is equal to the critical radius
 (B) The outer radius of the pipe is less than the critical radius
 (C) Adding the insulation will reduce the heat loss
 (D) Adding the insulation will increase the heat loss

Answer: - (C)

Explanation: - Critical Radius of Insulation = $\left(\frac{k}{h}\right) = \left(\frac{0.05}{5}\right) \text{m} = 10\text{mm}$

$(r_{\text{outer}}) > r_{\text{critical}} \Rightarrow$ Adding insulation shall decrease H.T. Rate.

16. The contents of a well-insulated tank are heated by a resistor of 23Ω in which 10A current is flowing. Consider the tank along with its contents as a thermodynamic system. The work done by the system and the heat transfer to the system are positive. The rates of heat (Q), work (W) and change in internal energy (ΔU) during the process in kW are
 (A) $Q = 0, W = -2.3, \Delta U = +2.3$ (B) $Q = +2.3, W = 0, \Delta U = +2.3$
 (C) $Q = -2.3, W = 0, \Delta U = -2.3$ (D) $Q = 0, W = +2.3, \Delta U = -2.3$

Answer: - (A)

Explanation: -

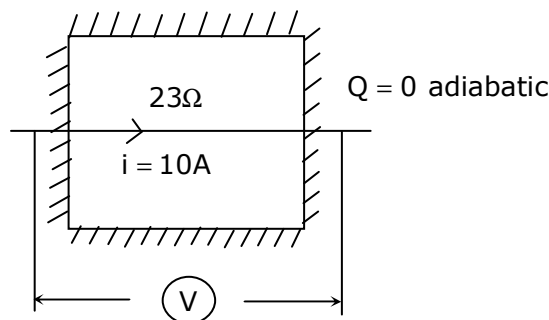

$$W_{\text{electric}} = i^2 R = (10^2 \times 20) \text{ watts} = -2.3 \text{ kw (on system)}$$

$$\text{I law : - } \phi - w = \Delta U$$

$$0 - (-W_{\text{elect}}) = \Delta u$$

17. Match the following criteria of material failure, under biaxial stresses σ_1 and σ_2 and yield stress σ_y , with their corresponding graphic representations :

P. Maximum-normal-stress criterion L.

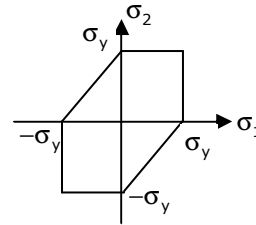

Q. Maximum-distortion-energy criterion M.

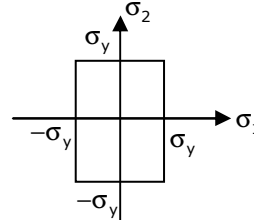

R. Maximum-shear-stress criterion N.

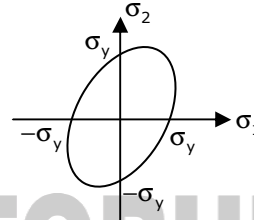

(A) P-M, Q-L, R-N (B) P-N, Q-M, R-L (C) P-M, Q-N, R-L (D) P-N, Q-L,R-M

Answer: - (C)

18. The product of two complex numbers $1 + i$ and $2 - 5i$ is
 (A) $7 - 3i$ (B) $3 - 4i$ (C) $-3 - 4i$ (D) $7 + 3i$

Answer: - (A)

Explanation: - $(1 + i)(2 - 5i) = 2 - 5i + 2i + 5 = 7 - 3i$

19. Cars arrive at a service station according to Poisson's distribution with a mean rate of 5 per hour. The service time per car is exponential with a mean of 10minutes. At steady state, the average waiting time in the queue is
 (A) 10 minutes (B) 20 minutes (C) 25 minutes (D) 50 minutes

Answer: - (D)

$$Wq = \frac{\rho}{\mu - \lambda}; \text{ Where } \lambda = 5/\text{hr}, \mu = 6/\text{hr}, \rho = \frac{\lambda}{\mu} = \frac{5}{6}; \therefore Wq = \frac{5}{6 - 5} = \frac{5}{1} \text{ hr} = 50 \text{ min}$$

20. The word **kanban** is most appropriately associated with
 (A) Economic order quantity (B) Just-in-time production
 (C) Capacity planning (D) Product design

Answer: - (B)

21. If $f(x)$ is an even function and a is a positive real number, then $\int_{-a}^a f(x) dx$ equals
- (A) 0 (B) a (C) $2a$ (D) $2\int_0^a f(x) dx$

Answer: - (D)

Explanation: - $\int_{-a}^a f(x) dx = \begin{cases} 2\int_0^a f(x) dx; & f(x) \text{ is even} \\ 0 & ; \quad f(x) \text{ is odd} \end{cases}$

22. The coefficient of restitution of a perfectly plastic impact is
- (A) 0 (B) 1 (C) 2 (D) ∞

Answer: - (A)

Explanation: - Coefficient of Restitution = $\frac{\text{Relative velocity of separation}}{\text{Relative velocity of approach}}$
= 0 for perfectly plastic impact

since both bodies cling together after impact.

23. A thin cylinder of inner radius 500mm and thickness 10mm is subjected to an internal pressure of 5MPa. The average circumferential (hoop) stress in MPa is
- (A) 100 (B) 250 (C) 500 (D) 1000

Answer: - (B)

Explanation: - Given Data: $p = 5\text{MPa}$; $d = 1000\text{mm}$; $t = 10\text{mm}$

$$\text{Hoop stress } \sigma_{\text{Hoop}} = \frac{pd}{2t} = 250 \text{ MPa}$$

24. Which one among the following welding processes uses non-consumable electrode?
- (A) Gas metal arc welding (B) Submerged arc welding
(C) Gas tungsten arc welding (D) Flux coated arc welding

Answer: - (C)

25. The crystal structure of austenite is
- (A) Body centered cubic (B) Face centered cubic
(C) Hexagonal closed packed (D) Body centered tetragonal

Answer: - (B)

Q. No. 26 – 51 Carry Two Marks Each

26. A torque T is applied at the free end of a stepped rod of circular cross-sections as shown in the figure. The shear modulus of the material of the rod is G . The expression for d to produce an angular twist θ at the free end is

- (A) $\left(\frac{32TL}{\pi\theta G}\right)^{\frac{1}{4}}$
- (B) $\left(\frac{18TL}{\pi\theta G}\right)^{\frac{1}{4}}$
- (C) $\left(\frac{16TL}{\pi\theta G}\right)^{\frac{1}{4}}$
- (D) $\left(\frac{2TL}{\pi\theta G}\right)^{\frac{1}{4}}$

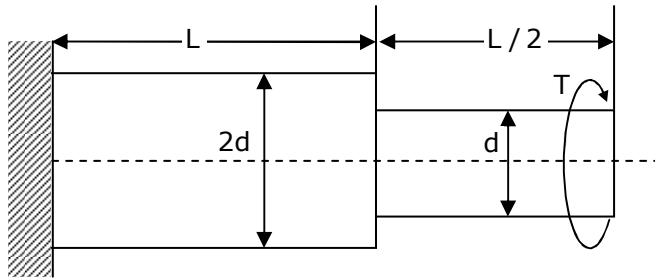

Answer: - (B)

Explanation: -Angular twist at the free end

$$\theta = \Sigma \left(\frac{TL}{GJ}\right) = \left(\frac{TL}{GJ}\right)_1 + \left(\frac{TL}{GJ}\right)_2 = \frac{T}{G} \left[\left(\frac{L}{J}\right)_1 + \left(\frac{L}{J}\right)_2 \right] = \frac{T}{G} \left[\frac{L}{\frac{\pi}{32}(2d)^4} + \frac{L/2}{\frac{\pi}{32}d^4} \right]$$

$$= \frac{TL}{\pi G d^4} \left[\frac{32}{16} + \frac{32}{2} \right] = \frac{18TL}{\pi G d^4}$$

$$\Rightarrow d = \left[\frac{18TL}{\pi G \theta} \right]^{\frac{1}{4}}$$

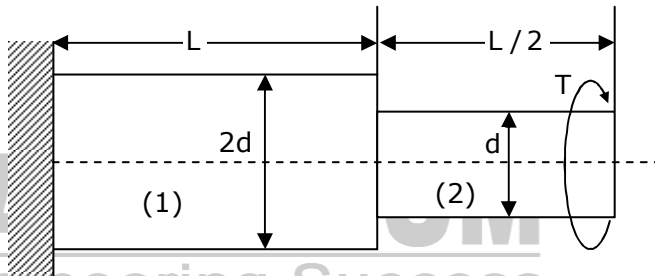

27. Figure shows the schematic for the measurement of velocity of air (density = 1.2kg/m³) through a constant-area duct using a pitot tube and a water-tube manometer. The differential head of water (density = 1000kg/m³) in the two columns of the manometer is 10mm. Take acceleration due to gravity as 9.8m/s². The velocity of air in m/s is

- (A) 6.4
- (B) 9.0
- (C) 12.8
- (D) 25.6

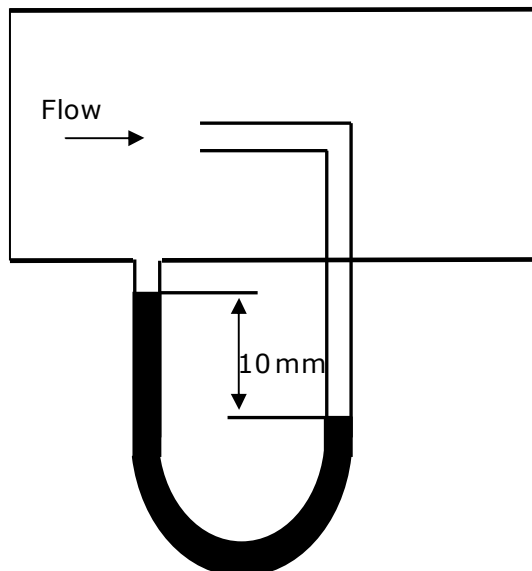

Answer: - (C)

Explanation: - From Bernoulli's equation

$$\frac{V_1^2 - V_2^2}{2g} = \frac{p_2 - p_1}{\rho_a g} \Rightarrow V_1 = \sqrt{\frac{2(p_2 - p_1)}{\rho_a}}$$

$$\text{But } P_2 - P_1 = (\rho g h)_{\text{water}} = 9810 \times 10 \times 10^{-3} = 98.1 \text{ N/m}^2 \therefore V_1 = \sqrt{\frac{2 \times 98.1}{1.2}} = 1.2 \text{ m/s}$$

28. The values of enthalpy of steam at the inlet and outlet of a steam turbine in a Rankine cycle are 2800kJ/kg and 1800kJ/kg respectively. Neglecting pump work, the specific steam consumption in kg/kW-hour is

- (A) 3.60 (B) 0.36 (C) 0.06 (D) 0.01

Answer: - (A)

Explanation: - Work done by the turbine

$$W = 2800 - 1800 = 1000 \text{ kJ/kg} = 1000 \text{ kW} \cdot \text{s/kg}$$

$$\text{Specific fuel consumption} = \frac{1}{1000} \times 3600 = 3.6 \text{ kg/kw-hr}$$

29. The integral $\int_1^3 \frac{1}{x} dx$, when evaluated by using Simpson's 1/3 rule on two equal subintervals each of length 1, equals

- (A) 1.000 (B) 1.098 (C) 1.111 (D) 1.120

Answer: - (C)

Explanation: - Given $\int_1^3 \frac{1}{x} dx$

$$\text{Here, } a = 1, b = 3, n = 2 \text{ and } h = \frac{b - a}{n} = 1$$

$x_0 = 1$	$x_1 = 2$	$x_2 = 3$
$y_0 = 1$	$y_2 = \frac{1}{2} = 0.5$	$y_3 = \frac{1}{3} = 0.33$

By Simpson's rule

$$\int_1^3 \frac{1}{x} dx = \frac{1}{3} h [(y_1 + y_3) + 4(y_2)] = \frac{1}{3} (1) [(1 + 0.33) + 4(0.51)] = 1.11$$

30. Two identical ball bearings P and Q are operating at loads 30kN and 45kN respectively. The ratio of the life of bearing P to the life of bearing Q is

- (A) 81/16 (B) 27/8 (C) 9/4 (D) 3/2

Answer: - (B)

Explanation: - For ball bearing $P, (L)^{\frac{1}{3}} = C$

$$\text{Given } P_p = 30\text{kN and } P_2 = 45\text{kN}$$

$$\frac{L_p}{L_2} = \left(\frac{P_2}{P_p}\right)^3 = \left(\frac{45}{30}\right)^3 = \left(\frac{3}{2}\right)^3 = \frac{27}{8}$$

31. For the four-bar linkage shown in the figure, the angular velocity of link AB is 1 rad/s. The length of link CD is 1.5 times the length of link AB. In the configuration shown, the angular velocity of link CD in rad/s is

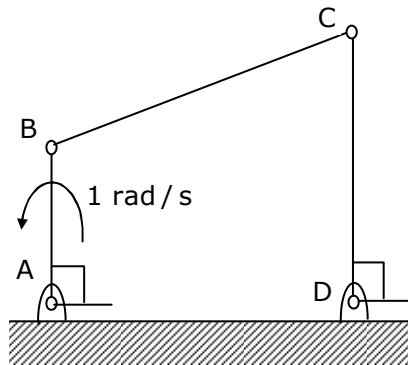

- (A) 3 (B) $\frac{3}{2}$ (C) 1 (D) $\frac{2}{3}$

Answer: - (D)

Explanation: -For the given configuration

$$V_{AB} = V_{CD} \Rightarrow \omega_{AB} AB = \omega_{CD} CD$$

$$\Rightarrow \omega_{CD} = \omega_{AB} \frac{AB}{CD} = 1 \times \frac{1}{1.5} = \frac{2}{3} \text{ rad/s}$$

32. A stone with mass of 0.1kg is catapulted as shown in the figure. The total force F_x (in N) exerted by the rubber band as a function of distance x (in m) is given by $F_x = 300x^2$. If the stone is displaced by 0.1m from the un-stretched position ($x=0$) of the rubber band, the energy stored in the rubber band is

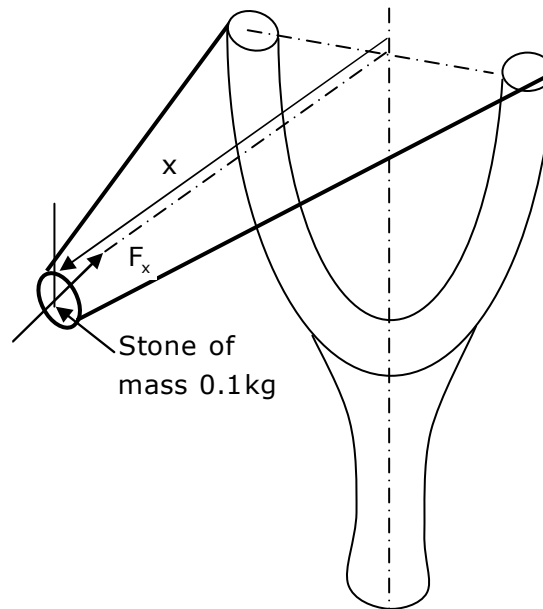

- (A) 0.01J (B) 0.1J (C) 1J (D) 10J

Answer: - (B)

Explanation: - Energy stored in the bar = W.D. by the stone

$$= \int_0^{0.1} F_x dx = \int_0^{0.1} 300 \cdot x^2 dx = 300 \cdot \frac{x^3}{3} = 100 \times 0.1^3 = 0.1 \text{ J}$$

33. Consider the differential equation $\frac{dy}{dx} = (1 + y^2)x$. The general solution with constant c is

(A) $y = \tan \frac{x^2}{2} + \tan c$

(B) $y = \tan^2 \left(\frac{x}{2} + c \right)$

(C) $y = \tan^2 \left(\frac{x}{2} \right) + c$

(D) $y = \tan \left(\frac{x^2}{2} + c \right)$

Answer: - (D)

Explanation: - Given differential equation is

$$\frac{dy}{dx} = (1 + y^2)x \Rightarrow \frac{dy}{1 + y^2} = x dx$$

Integrating on both sides, we have

$$\Rightarrow \tan^{-1} y = \frac{x^2}{2} + c \Rightarrow y = \tan \left(\frac{x^2}{2} + c \right)$$

34. An unbiased coin is tossed five times. The outcome of each toss is either a head or a tail. The probability of getting at least one head is

(A) $\frac{1}{32}$

(B) $\frac{13}{32}$

(C) $\frac{16}{32}$

(D) $\frac{31}{32}$

Answer: - (D)

Explanation: - $P(\text{at least one head}) = 1 - P(\text{no heads}) = 1 - \frac{1}{2^5} = \frac{31}{32}$

35. A mass of 1 kg is attached to two identical springs each with stiffness $k = 20 \text{ kN/m}$ as shown in the figure. Under frictionless condition, the natural frequency of the system in Hz is close to

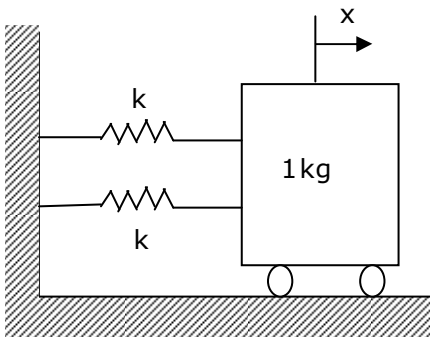

(A) 32

(B) 23

(C) 16

(D) 11

Answer: - (A)

Explanation: - Natural frequency of the system

$$\omega_n = \sqrt{\frac{k_e}{m}}$$

Where $k_e = k + k = 2k = 2 \times 20 = 40 \text{ kN/m}$

$$\omega_n = \sqrt{\frac{40 \times 1000}{1}} = 200 \text{ rad/s} = 32 \text{ Hz}$$

36. The shear strength of a sheet metal is 300MPa. The blanking force required to produce a blank of 100mm diameter from a 1.5 mm thick sheet is close to
 (A) 45kN (B) 70kN (C) 141kN (D) 3500kN

Answer: - (C)

Explanation: - Blanking force = $\tau \cdot A_s = 300 \times \pi dt = 300 \times \pi \times 100 \times 1.5 = 141 \text{ kN}$

37. The ratios of the laminar hydrodynamic boundary layer thickness to thermal boundary layer thickness of flows of two fluids P and Q on a flat plate are $\frac{1}{2}$ and 2 respectively. The Reynolds number based on the plate length for both the flows is 10^4 . The Prandtl and Nusselt numbers for P are $\frac{1}{8}$ and 35 respectively. The Prandtl and Nusselt numbers for Q are respectively
 (A) 8 and 140 (B) 8 and 70 (C) 4 and 70 (D) 4 and 35

Answer: - (A)

Explanation: - $\frac{\delta_t}{\delta} = \frac{1}{1.026} \times Pr^{-1/3}$

$$\text{For fluid Q: } - \frac{1}{2} = \frac{\delta_t}{\delta} = \frac{1}{1.026} Pr^{-1/3} \Rightarrow Pr = 8$$

For fluid P : - from Laminar flow over flat plate

$$Nu = 0.664 Re_L^{1/2} Pr^{1/3} \Rightarrow Nu = 35$$

Similarly for fluid Q :

$$Nu = 0.664 Re_L^{1/2} Pr^{1/3} = 0.664 (10^4)^{1/2} 8^{1/3} \approx 140$$

38. The crank radius of a single-cylinder I. C. engine is 60mm and the diameter of the cylinder is 80mm. The swept volume of the cylinder in cm^3 is
 (A) 48 (B) 96 (C) 302 (D) 603

Answer: - (D)

Explanation: - Stroke of the cylinder $l = 2r = 2 \times 60 = 120 \text{ mm}$

$$\text{Swept volume} = \frac{\pi}{4} d^2 \times l = \frac{\pi}{4} \times 80^2 \times 120 = 603 \text{ cm}^3$$

39. A pump handling a liquid raises its pressure from 1 bar to 30 bar. Take the density of the liquid as 990 kg/m^3 . The isentropic specific work done by the pump in kJ/kg is

(A) 0.10 (B) 0.30 (C) 2.50 (D) 2.93

Answer: - (D)

Explanation: - Work done by the pump = $v(p_2 - p_1) = \frac{(30 - 1) \times 100}{990} = 2.93 \text{ kJ/kg}$

40. A spherical steel ball of 12mm diameter is initially at 1000K. It is slowly cooled in a surrounding of 300K. The heat transfer coefficient between the steel ball and the surrounding is $5 \text{ W/m}^2\text{K}$. The thermal conductivity of steel is 20 W/mK . The temperature difference between the centre and the surface of the steel ball is

(A) Large because conduction resistance is far higher than the convective resistance
 (B) Large because conduction resistance is far less than the convective resistance
 (C) Small because conduction resistance is far higher than the convective resistance
 (D) Small because conduction resistance is far less than the convective resistance

Answer: - (D)

Explanation: - $Bi = \frac{hL}{K} = \frac{5 \times 0.002}{20} = 0.0005$

For the given condition the Biot number tends to zero, that means conduction resistance is far less than convection resistance. Therefore temperature between the centre and surface is very small.

41. An ideal Brayton cycle, operating between the pressure limits of 1 bar and 6 bar, has minimum and maximum temperatures of 300K and 1500K. The ratio of specific heats of the working fluid is 1.4. The approximate final temperatures in Kelvin at the end of the compression and expansion processes are respectively

(A) 500 and 900 (B) 900 and 500 (C) 500 and 500 (D) 900 and 900

Answer: - (A)

Explanation: - Ideal Brayton cycle

At the end of compression, temperature.

$$T_2 = T_1 \left(\frac{P_3}{P_4} \right)^{\frac{\gamma-1}{\gamma}} = 300 \times 6^{\frac{0.4}{1.4}} = 500\text{K}$$

At the end of expansion; temperature.

$$T_4 = \frac{T_3}{\left(\frac{P_3}{P_4} \right)^{\frac{\gamma-1}{\gamma}}} = \frac{1500}{6^{\frac{0.4}{1.4}}} = 900\text{K}$$

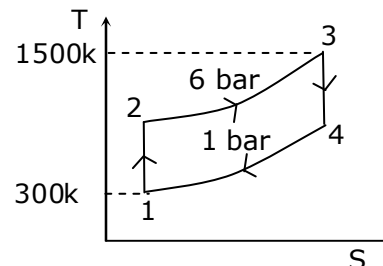

42. A disc of mass m is attached to a spring of stiffness k as shown in the figure. The disc rolls without slipping on a horizontal surface. The natural frequency of vibration of the system is

- (A) $\frac{1}{2\pi} \sqrt{\frac{k}{m}}$
 (B) $\frac{1}{2\pi} \sqrt{\frac{2k}{m}}$
 (C) $\frac{1}{2\pi} \sqrt{\frac{2k}{3m}}$
 (D) $\frac{1}{2\pi} \sqrt{\frac{3k}{2m}}$

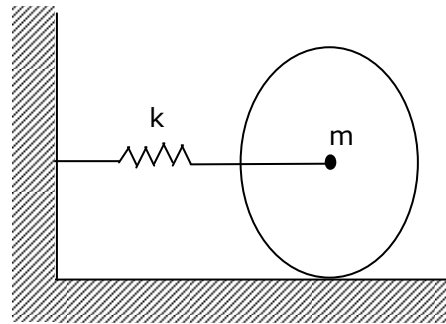

Answer: - (C)

Explanation: -

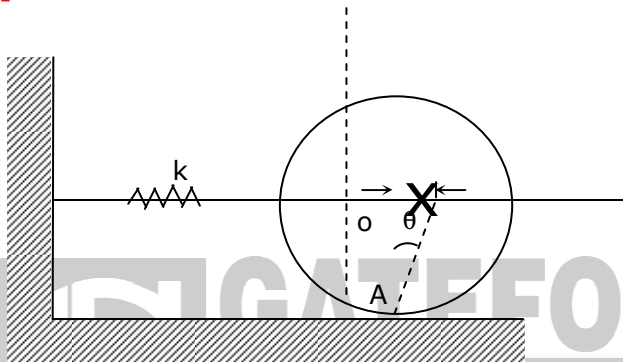

Taking moments about instantaneous centre 'A'

$$I_a \ddot{\theta} + (kx) r = 0$$

$$\Rightarrow (I_o + mr^2) \ddot{\theta} + kx (\theta r) = 0$$

$$\Rightarrow \left(\frac{1}{2} mr^2 + mr^2 \right) \ddot{\theta} + k (\theta r^2) = 0$$

$$\Rightarrow \ddot{\theta} + \frac{kr^2}{\frac{3}{2} mr^2} \theta = 0 \Rightarrow \ddot{\theta} + \frac{2k}{3m} \theta = 0; \therefore \omega_n = \frac{1}{2\pi} \sqrt{\frac{2k}{3m}}$$

43. A 1 kg block is resting on a surface with coefficient of friction $\mu = 0.1$. A force of 0.8N is applied to the block as shown in figure. The friction force is

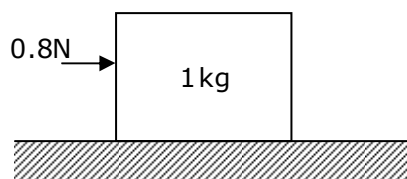

- (A) 0 (B) 0.8N (C) 0.98N (D) 1.2N

Answer: - (B)

Explanation: -Limiting friction force between the block and the surface is 0.98N. But the applied force is 0.8N which is less than the limiting friction force. Therefore the friction force for the given case is 0.8N.

44. Consider the following system of equations

$$2x_1 + x_2 + x_3 = 0,$$

$$x_2 - x_3 = 0,$$

$$x_1 + x_2 = 0.$$

This system has

(A) A unique solution

(B) No solution

(C) Infinite number of solutions

(D) Five solutions

Answer: - (C)

Explanation: - Given equations are

$$2x_1 + x_2 + x_3 = 0. \dots\dots\dots(1) \quad x_2 - x_3 = 0. \dots\dots\dots(2)$$

$$\text{and } x_1 + x_2 = 0. \dots\dots\dots(3)$$

$$\text{Eliminating } x_3 \text{ from (1) \& (2), we have } x_1 + x_2 = 0. \dots\dots\dots(4)$$

Clearly (3) & (4) are coincident i.e. they will meet at infinite points

Hence the given equations have infinite solutions

45. A single-point cutting tool with 12° rake angle is used to machine a steel work-piece. The depth of cut, i.e. uncut thickness is 0.81mm. The chip thickness under orthogonal machining condition is 1.8mm. The shear angle is approximately

(A) 22°

(B) 26°

(C) 56°

(D) 76°

Answer: - (B)

Explanation: Relation between shear angle (ϕ), chip thickness ratio (r) and rake angle (α) is given by

$$\tan \phi = \frac{r \cos \alpha}{1 - r \sin \alpha}$$

$$\text{Where } r = \frac{0.81}{1.8} = 0.45$$

$$\tan \phi = \frac{0.45 \cos 12}{1 - 0.45 \sin 12} \Rightarrow \phi = 26^\circ$$

46. Match the following non-traditional machining processes with the corresponding material removal mechanisms :

Machining process

Mechanism of material removal

P. Chemical machining

1. Erosion

Q. Electro-chemical machining

2. Corrosive reaction

R. Electro - discharge machining

3. Ion displacement

S. Ultrasonic machining

4. Fusion and vaporization

- (A) P-2, Q-3, R-4, S-1 (B) P-2, Q-4, R-3, S-1
 (C) P-3, Q-2, R-4, S-1 (D) P-2, Q-3, R-1, S-4

Answer: - (A)

47. A cubic casting of 50mm side undergoes volumetric solidification shrinkage and volumetric solid contraction of 4% and 6% respectively. No. riser is used. Assume uniform cooling in all directions. The side of the cube after solidification and contraction is
- (A) 48.32mm (B) 49.90mm (C) 49.94mm (D) 49.96mm

Answer: - (A)

Explanation: - Volumetric solidification shrinkage and volumetric solid contraction cause decrease in dimensions.

$$\text{Volume of cube} = 50^3 = 125000 \text{ mm}^3$$

After considering both the allowances

$$V = 125000 \times 0.96 \times 0.94 = 112800 \text{ mm}^3$$

$$\text{Side of cube} = \sqrt[3]{112800} = 48.32 \text{ mm}$$

Common Data Questions: 48 & 49

In an experimental set-up, air flows between two stations P and Q adiabatically. The direction of flow depends on the pressure and temperature conditions maintained at P and Q. The conditions at station P are 150kPa and 350K. The temperature at station Q is 300K.

The following are the properties and relations pertaining to air:

Specific heat at constant pressure, $C_p = 1.005 \text{ kJ/kgK}$;

Specific heat at constant volume, $C_v = 0.718 \text{ kJ/kgK}$;

Characteristic gas constant, $R = 0.287 \text{ kJ/kgK}$

Enthalpy, $h = c_p T$

Internal energy, $u = c_v T$

48. If the air has to flow from station P to station Q, the maximum possible value of pressure in kPa at station Q is close to
- (A) 50 (B) 87 (C) 128 (D) 150

Answer: - (B)

Explanation: - To cause the flow from P to Q, change in entropy ($S_p - S_Q$) should be greater than zero

$$\text{i.e. } S_p - S_Q > 0, \text{ or let us say } S_1 - S_2 > 0$$

$$\Rightarrow C_v \ln \left(\frac{T_2}{T_1} \right) + R \ln \left(\frac{v_2}{v_1} \right) > 0$$

$$\Rightarrow 0.718 \ln \left(\frac{300}{350} \right) + 0.287 \ln \left(\frac{v_2}{v_1} \right) > 0$$

$$\Rightarrow -0.1107 + 0.287 \ln \left(\frac{v_2}{v_1} \right) > 0 \Rightarrow \ln \left(\frac{v_2}{v_1} \right) > \frac{0.1107}{0.287}$$

$$\Rightarrow \frac{v_2}{v_1} > 1.47$$

$$\text{From Perfect gas law } \frac{P_1 v_1}{T_1} = \frac{P_2 v_2}{T_2}$$

$$\Rightarrow \frac{v_2}{v_1} = \frac{P_1 T_2}{P_2 T_1}$$

$$\therefore \frac{P_1 T_2}{P_2 T_1} > 1.47 \Rightarrow P_2 < \frac{150 \times 300}{350 \times 1.47}$$

$$\Rightarrow P_2 < 87.4 \text{ kPa}$$

\therefore The maximum value of pressure at Q = 87 kPa

49. If the pressure at station Q is 50kPa, the change in entropy ($s_Q - s_p$) in kJ/kgK is
 (A) -0.155 (B) 0 (C) 0.160 (D) 0.355

Answer: - (C)

Explanation: $-S_Q - S_p = C_v \ln \left(\frac{T_2}{T_1} \right) + R \ln \left(\frac{v_2}{v_1} \right)$

From the perfect gas law

$$\frac{v_2}{v_1} = \frac{P_1 T_2}{P_2 T_1} = \frac{150 \times 300}{300 \times 350} = 2.57$$

$$\therefore S_a - S_p = -0.1107 + 0.287 \ln 2.57 = 0.16 \text{ kJ/kgK}$$

Common Data Questions: 50 & 51

One unit of product P_1 requires 3 kg of resource R_1 and 1kg of resource R_2 . One unit of product P_2 requires 2kg of resource R_1 and 2kg of resource R_2 . The profits per unit by selling product P_1 and P_2 are Rs.2000 and Rs.3000 respectively. The manufacturer has 90kg of resource R_1 and 100kg of resource R_2 .

50. The unit worth of resource R_2 i.e., dual price of resource R_2 in Rs. Per kg is
 (A) 0 (B) 1350 (C) 1500 (D) 2000

Answer: - (A)

Explanation: -Because the constraint on resource 2 has no effect on the feasible region.

51. The manufacturer can make a maximum profit of Rs.
 (A) 60000 (B) 135000 (C) 150000 (D) 200000

Answer: - (B)

Explanation: -Optimum solution is: 0, 45 and maximum profit = Rs.135000

Linked Answer Questions: Q.52 to Q.55 Carry Two Marks Each

Statement for Linked Answer Questions: 52 & 53

A triangular-shaped cantilever beam of uniform-thickness is shown in the figure. The Young's modulus of the material of the beam is E . A concentrated load P is applied at the free end of the beam.

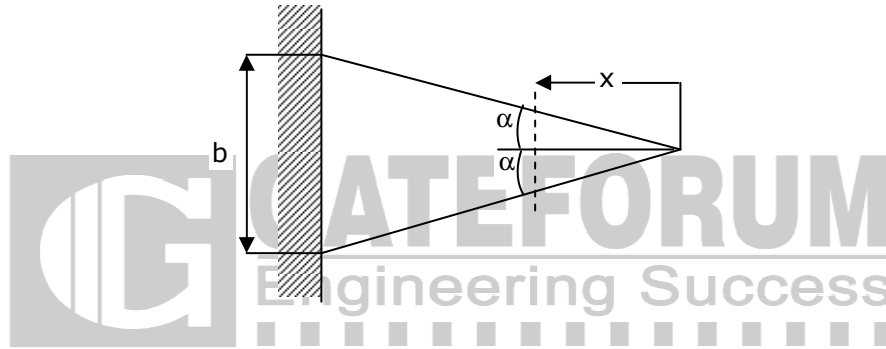
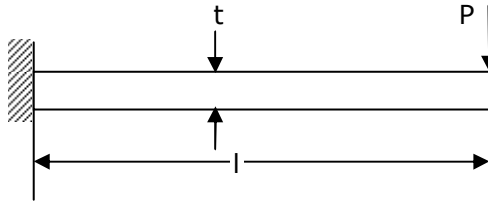

52. The area moment of inertia about the neutral axis of a cross-section at a distance x measured from the free end is

(A) $\frac{bxt^3}{6l}$ (B) $\frac{bxt^3}{12l}$ (C) $\frac{bxt^3}{24l}$ (D) $\frac{xt^3}{12}$

Answer: - (B)

Explanation: -

At a distance of x from the free end width $b' = \frac{bx}{l}$; \therefore Moment of Inertia $I_x = \frac{bxt^3}{12l}$

53. The maximum deflection of the beam is

(A) $\frac{24Pl^3}{Ebt^3}$ (B) $\frac{12Pl^3}{Ebt^3}$ (C) $\frac{8Pl^3}{Ebt^3}$ (D) $\frac{6Pl^3}{Ebt^3}$

Answer: - (D)

Explanation: -

The maximum deflection of the beam $y_{\max} = \frac{Pl^3}{3EI} = \frac{6Pl^3}{Ebt^3}$; Where $I = \frac{bt^3}{12l}$

Statement for Linked Answer Questions: 54 & 55

The temperature and pressure of air in a large reservoir are 400K and 3 bar respectively. A converging-diverging nozzle of exit area 0.005m^2 is fitted to the wall of the reservoir as shown in the figure. The static pressure of air at the exit section for isentropic flow through the nozzle is 50kPa. The characteristic gas constant and the ratio of specific heats of air are 0.287kJ/kgK and 1.4 respectively.

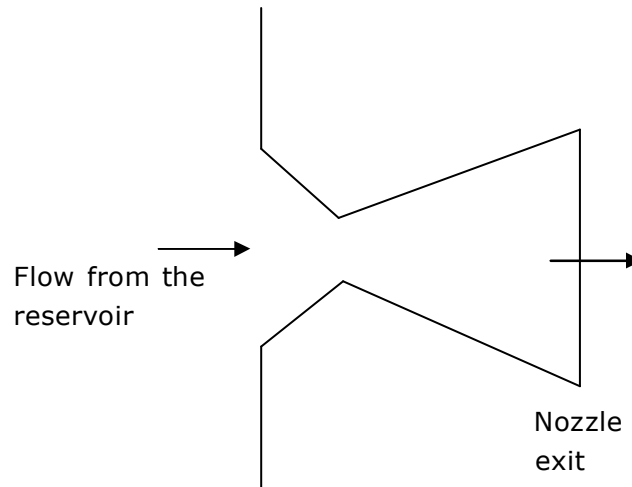

54. The density of air in kg/m^3 at the nozzle exit is
 (A) 0.560 (B) 0.600 (C) 0.727 (D) 0.800

Answer: - (C)

Explanation: - Given data:

$$T_1 = 400\text{K}, P_1 = 300\text{kPa}, P_2 = 50\text{kPa}, R = 0.287\text{kJ/kgK}$$

$$\gamma = 1.4, A_2 = 0.005\text{m}^2$$

The happened process from entrance to exit is isentropic process, therefore

$$\frac{T_2}{T_1} = \left(\frac{P_2}{P_1}\right)^{\frac{\gamma-1}{\gamma}} \Rightarrow T_2 = 400 \left(\frac{50}{300}\right)^{0.4} = 239.5\text{K}$$

From the perfect gas equation

$$\rho = \frac{P}{RT} \text{ or } \rho_2 = \frac{P_2}{RT_2} = \frac{50}{0.287 \times 339.5} \Rightarrow \rho_2 = 0.727\text{ kg/m}^3$$

55. The mass flow rate of air through the nozzle in kg/s is
 (A) 1.30 (B) 1.77 (C) 1.85 (D) 2.06

Answer: - (D)

Explanation: - Mass flow rate $m = \rho Q$

$$\text{Where } Q = A_2 V_2; \text{ But } V_2 = \sqrt{2C_p(T_1 - T_2)} = \sqrt{2 \times 1.005 \times (400 - 239.5)}$$

$$V_2 = 568\text{ m/s}$$

$$\therefore m = 0.727 \times 0.005 \times 568 = 2.06\text{ kg/s}$$

Q. No. 56 – 60 Carry One Mark Each

56. Choose the word from the options given below that is most nearly opposite in meaning to the given word: **Amalgamate**
 (A) Merge (B) Split (C) Collect (D) Separate

Answer: - (B)

Exp: - Amalgamate means combine or unite to form one organization or structure. So the best option here is split. Separate on the other hand, although a close synonym, it is too general to be the best antonym in the given question while Merge is the synonym; Collect is not related.

57. Which of the following options is the closest in the meaning to the word below:
Inexplicable
 (A) Incomprehensible (B) Indelible
 (C) Inextricable (D) Infallible

Answer: - (A)

Exp: - Inexplicable means not explicable; that cannot be explained, understood, or accounted for. So the best synonym here is incomprehensible.

58. If $\log(P) = (1/2)\log(Q) = (1/3)\log(R)$, then which of the following options is TRUE?
 (A) $P^2 = Q^3R^2$ (B) $Q^2 = PR$ (C) $Q^2 = R^3P$ (D) $R = P^2Q^2$

Answer: - (B)

Exp:- $\log P = \frac{1}{2} \log Q = \frac{1}{3} \log(R) = k$

$$\therefore P = b^k, Q = b^{2k}, R = b^{3k}$$

$$\text{Now, } Q^2 = b^{4k} = b^{3k} b^k = PR$$

59. Choose the most appropriate word(s) from the options given below to complete the following sentence.
I contemplated_____Singapore for my vacation but decided against it.
 (A) To visit (B) having to visit (C) visiting (D) for a visit

Answer: - (C)

Exp: - Contemplate is a transitive verb and hence is followed by a gerund Hence the correct usage of contemplate is verb+ ing form.

60. Choose the most appropriate word from the options given below to complete the following sentence.
If you are trying to make a strong impression on your audience, you cannot do so by being understated, tentative or_____.
 (A) Hyperbolic (B) Restrained
 (C) Argumentative (D) Indifferent

Answer: - (B)

Exp: - The tone of the sentence clearly indicates a word that is similar to understated is needed for the blank. Alternatively, the word should be antonym of strong (fail to make strong impression). Therefore, the best choice is restrained which means controlled/reserved/timid.

Q. No. 61 – 65 Carry Two Marks Each

61. A container originally contains 10 litres of pure spirit. From this container 1 litre of spirit is replaced with 1 litre of water. Subsequently, 1 litre of the mixture is again replaced with 1 litre of water and this process is repeated one more time. How much spirit is now left in the container?

- (A) 7.58 litres (B) 7.84 litres (C) 7 litres (D) 7.29 litres

Answer: - (D)

$$\text{Exp:- } 10 \left(\frac{10-1}{10} \right)^3 = 10 \left(\frac{9}{10} \right)^3 = \frac{729}{1000}$$

$$\therefore \frac{729}{1000} \times 1 = 7.29 \text{ litres}$$

62. **Few school curricula include a unit on how to deal with bereavement and grief, and yet all students at some point in their lives suffer from losses through death and parting.**

Based on the above passage which topic would not be included in a unit on bereavement?

- (A) how to write a letter of condolence
 (B) what emotional stages are passed through in the healing process
 (C) what the leading causes of death are
 (D) how to give support to a grieving friend

Answer: - (C)

Exp: - The given passage clearly deals with how to deal with bereavement and grief and so after the tragedy occurs and not about precautions. Therefore, irrespective of the causes of death, a school student rarely gets into details of causes—which is beyond the scope of the context. Rest all are important in dealing with grief.

63. P, Q, R and S are four types of dangerous microbes recently found in a human habitat. The area of each circle with its diameter printed in brackets represents the growth of a single microbe surviving human immunity system within 24 hours of entering the body. The danger to human beings varies proportionately with the toxicity, potency and growth attributed to a microbe shown in the figure below

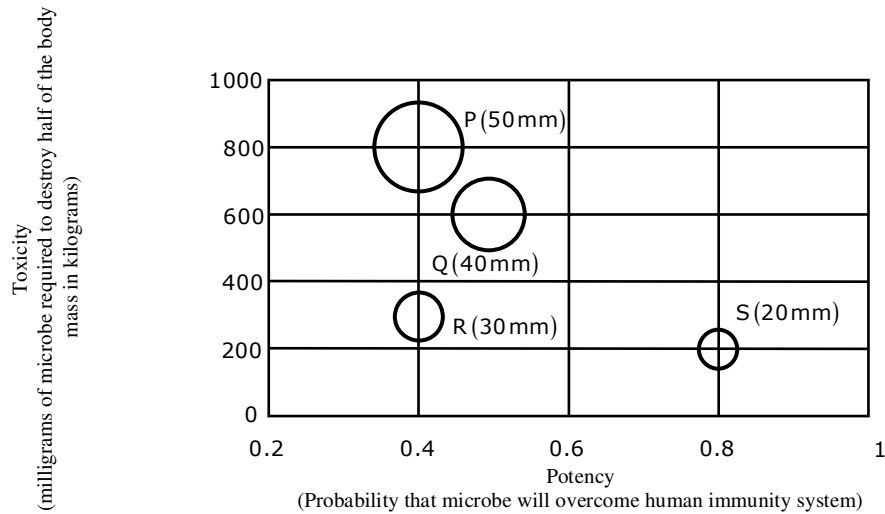

A pharmaceutical company is contemplating the development of a vaccine against the most dangerous microbe. Which microbe should the company target in its first attempt?

- (A) P (B) Q (C) R (D) S

Answer: - (D)

Exp: - By observation of the table, we can say S

	P	Q	R	S
Requirement	800	600	300	200
Potency	0.4	0.5	0.4	0.8

64. The variable cost (V) of manufacturing a product varies according to the equation $V = 4q$, where q is the quantity produced. The fixed cost (F) of production of same product reduces with q according to the equation $F = 100/q$. How many units should be produced to minimize the total cost (V+F)?

- (A) 5 (B) 4 (C) 7 (D) 6

Answer: (A)

Exp: - Checking with all options in formula: $(4q+100/q)$ i.e. (V+F). Option A gives the minimum cost.

65. A transporter receives the same number of orders each day. Currently, he has some pending orders (backlog) to be shipped. If he uses 7 trucks, then at the end of the 4th day he can clear all the orders. Alternatively, if he uses only 3 trucks, then all the orders are cleared at the end of the 10th day. What is the minimum number of trucks required so that there will be no pending order at the end of the 5th day?

- (A) 4 (B) 5 (C) 6 (D) 7

Answer: - (C)

Exp: - Let each truck carry 100 units.

$$2800 = 4n + e \quad n = \text{normal}$$

$$3000 = 10n + e \quad e = \text{excess/pending}$$

$$\therefore n = \frac{100}{3}, e = \frac{8000}{3}$$

$$5 \text{ days} \Rightarrow 500x = \frac{5 \cdot 100}{3} + \frac{8000}{3}$$

$$\Rightarrow 500x = \frac{8500}{3} \quad 17 \Rightarrow x > 5$$

Minimum possible = 6

